

Fisher-Price®

www.fisher-price.com

73499



**Please keep this instruction sheet for future reference,
as it contains important information.**

Requires three “AA” batteries (included).

Adult assembly is required.

**Tool required for assembly:
Phillips screwdriver (not included).**



Stride-to-Ride Walker™

Parts

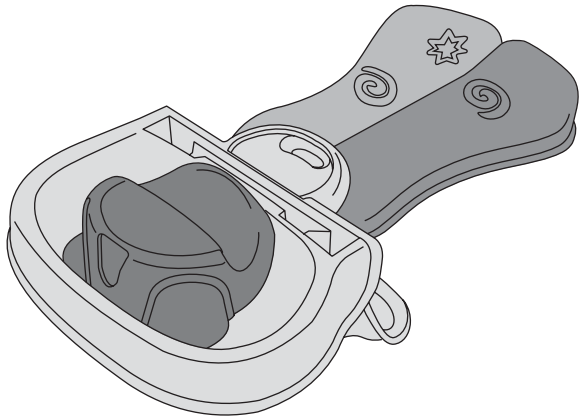

Base

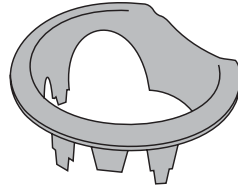

Basket

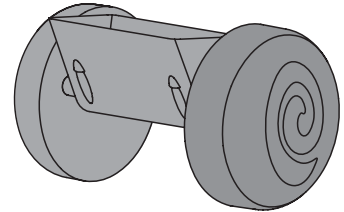

Wheel Assembly



Backboard

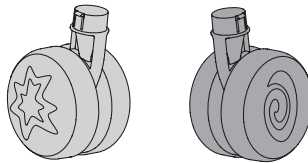

2 Caster Wheels



3 Balls

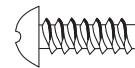

#8 x 1/2" (1,3 cm) Screw - 4

Shown Actual Size

Assembly



CAUTION

This product contains small parts in its unassembled state.
Adult assembly is required.

1

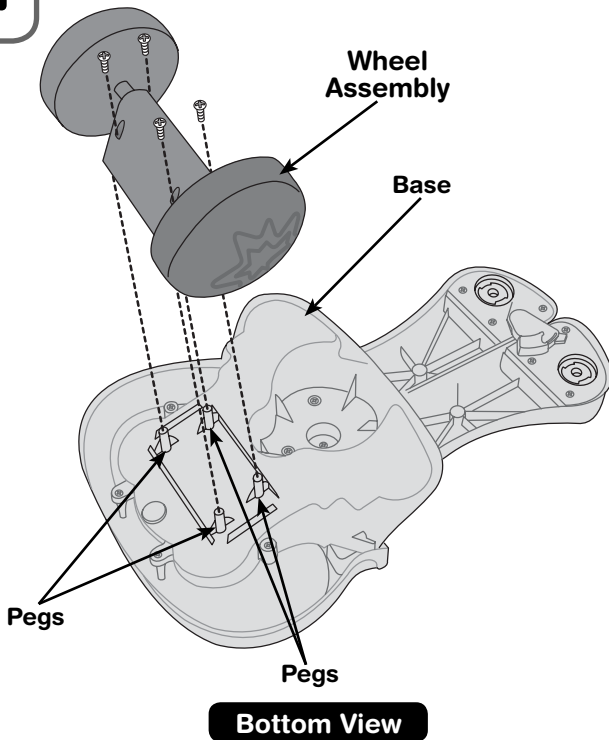

- Place the base upside down on a flat surface.
- Fit the wheel assembly onto the pegs on the base, as shown
- Insert four #8 x 1/2" (1,3 cm) screws through the holes in the wheel assembly and into the pegs on the base. Tighten the screws with a Phillips screwdriver. Do not over-tighten.

2

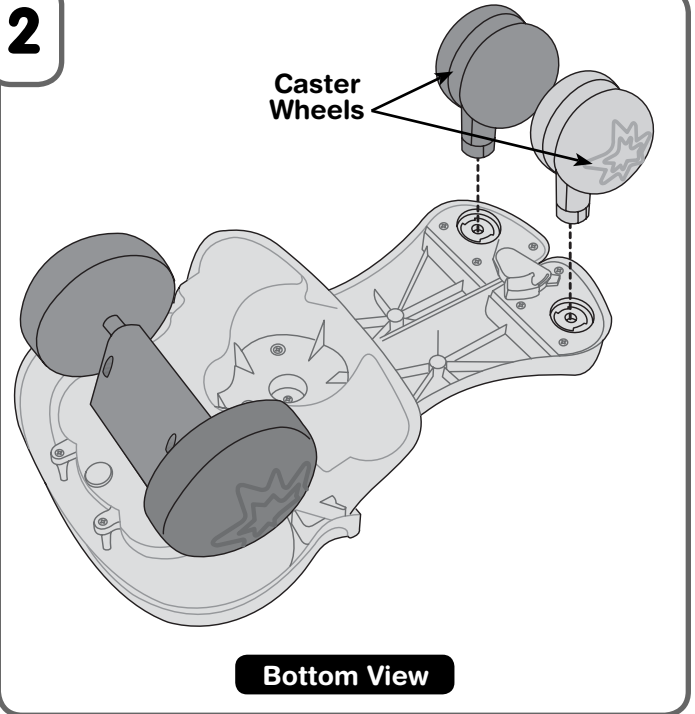

- Insert and “snap” the caster wheels into the base, as shown. This may require some force.
- Turn the base over.

Assembly

3

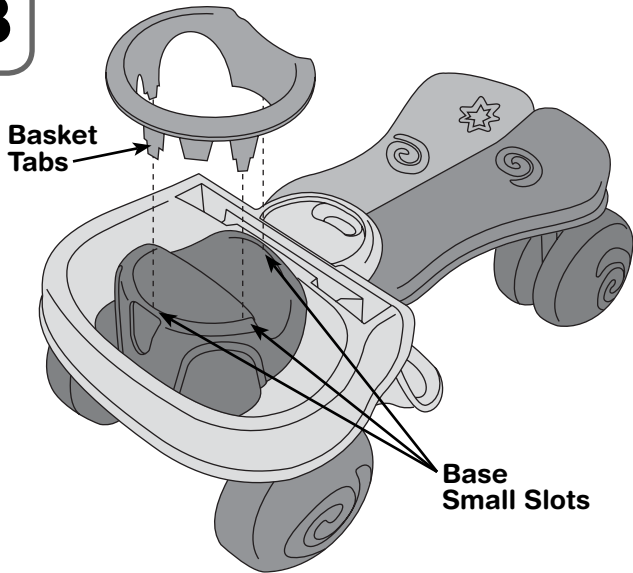

- Insert and “**snap**” the basket tabs into the small slots in the topside of the base.

4

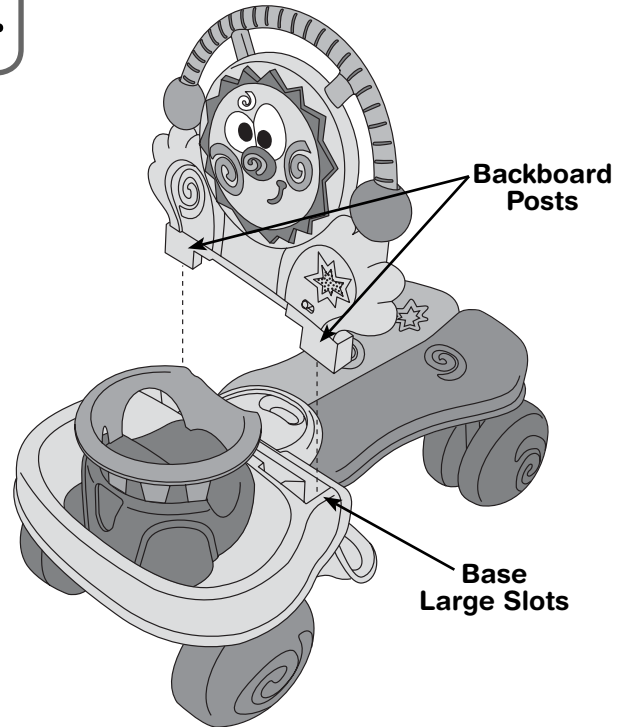

- Insert and “**snap**” the backboard posts into the large slots in the topside of the base.

***Hint:** You may need to rock the backboard to secure it properly into the base.*

One time assembly is now complete.

Battery Replacement

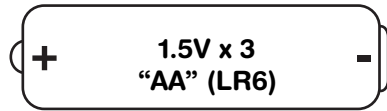

SHOWN ACTUAL SIZE

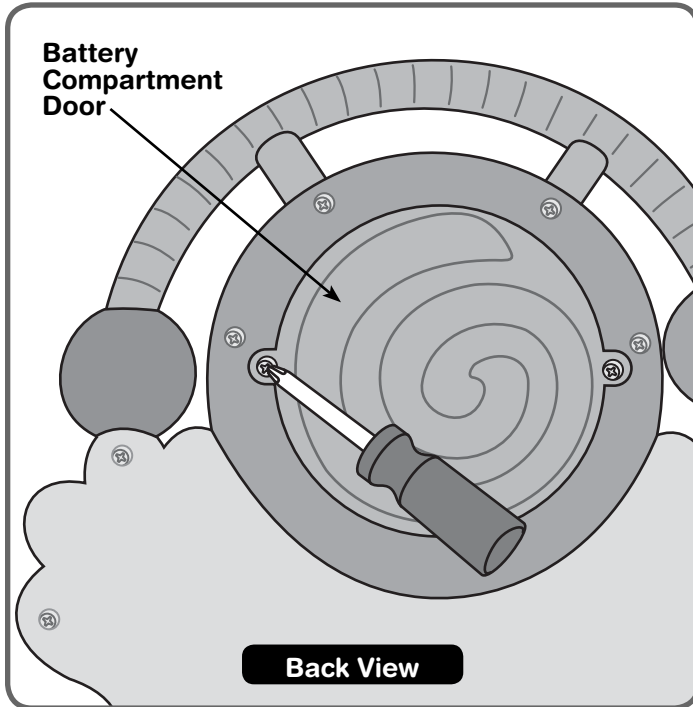

Back View

For best performance, we recommend replacing the batteries that came with this toy with three, new alkaline "AA" (LR6) batteries.

- Locate the battery compartment on the backboard.
- Loosen the screws in the battery compartment door with a Phillips screwdriver. Remove the battery compartment door.
- Insert three "AA" (LR6) **alkaline** batteries, as indicated inside the battery compartment.

Hint: We recommend using **alkaline** batteries for longer battery life.

- Replace the battery compartment door and tighten the screws with a Phillips screwdriver. Do not over-tighten.
- When lights or sounds from this toy become faint or stop, it's time for an adult to change the batteries!

Battery Safety Information



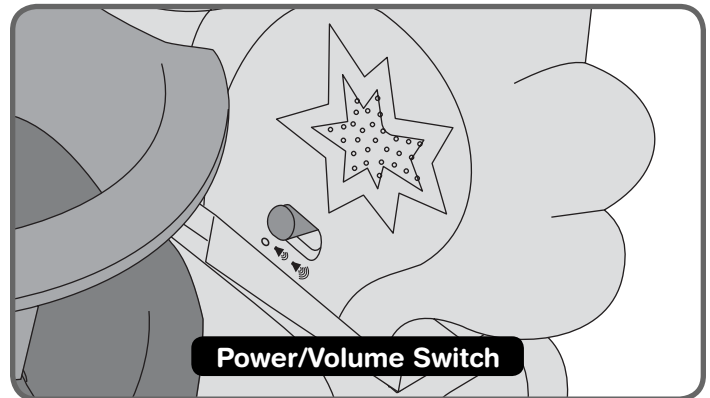

In exceptional circumstances, batteries may leak fluids that can cause a chemical burn injury or ruin your product. To avoid battery leakage:

- Do not mix old and new batteries or batteries of different types: alkaline, standard (carbon-zinc) or rechargeable (nickel-cadmium).
- Insert batteries as indicated inside the battery compartment.
- Remove batteries during long periods of non-use. Always remove exhausted batteries from the product. Dispose of batteries safely. Do not dispose of product in a fire. The batteries inside may explode or leak.
- Never short-circuit the battery terminals.
- Use only batteries of the same or equivalent type, as recommended.
- Do not charge non-rechargeable batteries.
- Remove rechargeable batteries from the product before charging.
- If removable, rechargeable batteries are used, they are only to be charged under adult supervision.

Power/Volume Switch



Power/Volume Switch

- Locate the power/volume switch on the backboard.
- The switch has three positions: off , on with low volume  and on with high volume .
- Slide the switch to off  position when the toy is not in use.

Walker

To change to Walker mode, follow these steps:

1

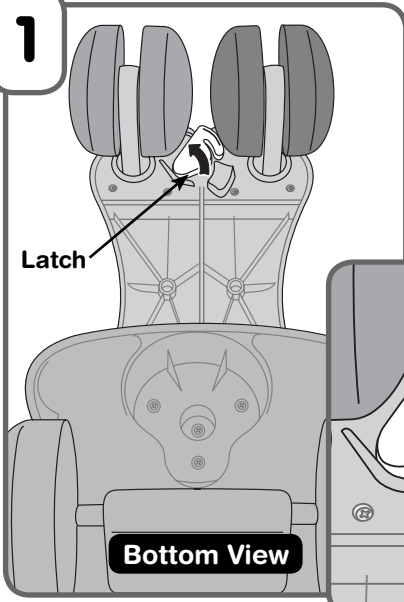

- Turn the toy over. Press and slide the latch to an open position, as shown.

2

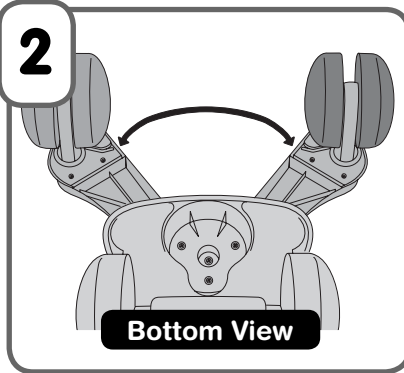

- Spread the seat halves until they “click” in place. Turn the toy over. It is now ready to be used as a walker.

Press the nose or walk along for fun music and dancing lights!



Ball play! Toss the balls into the hoop.

Ride-On

To change to Ride-On mode, follow these steps:

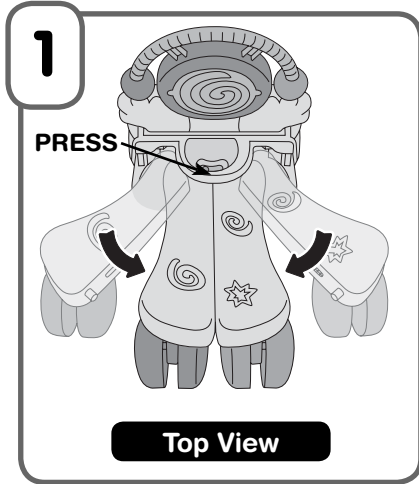

- Press the button and hold it while closing the seat halves. Turn the toy over.

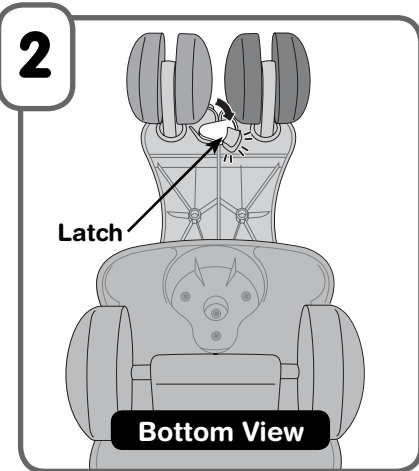

- Slide the latch to a closed position. It should “click” into place. Turn the toy over. It is now ready to be used as a ride-on.



Press the nose or roll along for fun music and dancing lights!

Ball play! Toss the balls into the hoop.

Care

- Wipe this toy with a clean cloth dampened with a mild soap and water solution. Do not immerse this toy.
- This toy has no consumer serviceable parts. Do not take this toy apart.
- Do not drop this toy on a hard surface.

FCC Statement (United States Only)

This equipment has been tested and found to comply with the limits for a Class B digital device, pursuant to Part 15 of the FCC Rules. These limits are designed to provide reasonable protection against harmful interference in a residential installation. This equipment generates, uses and can radiate radio frequency energy and, if not installed and used in accordance with the instructions, may cause harmful interference to radio communications. However, there is no guarantee that interference will not occur in a particular installation. If this equipment does cause harmful interference to radio or television reception, which can be determined by turning the equipment off and on, the user is encouraged to try to correct the interference by one or more of the following measures:

- Reorient or relocate the receiving antenna.
- Increase the separation between the equipment and receiver.
- Consult the dealer or an experienced radio/TV technician for help.

Note: Changes or modifications not expressly approved by the manufacturer responsible for compliance could void the user's authority to operate the equipment.

Consumer Information

Visit us on line at www.service.fisher-price.com.

Call Fisher-Price® Consumer Relations, toll-free at **1-800-432-5437**, 8 AM - 6 PM EST Monday through Friday. Hearing-impaired consumers using TTY/TDD equipment, please call 1-800-382-7470.

Write to us at: Fisher-Price® Consumer Relations, 636 Girard Avenue, East Aurora, New York 14052.

For countries outside the United States:

CANADA: Questions? 1-800-432-5437. Mattel Canada Inc., 6155 Freemont Blvd., Mississauga, Ontario L5R 3W2; www.service.mattel.com.

GREAT BRITAIN: Mattel UK Ltd, Vanwall Business Park, Maidenhead SL6 4UB. Helpline: 01628 500303; www.service.mattel.com/uk

AUSTRALIA: Mattel Australia Pty. Ltd., 658 Church Street, Locked Bag #870, Richmond, Victoria 3121 Australia. Consumer Advisory Service 1300 135 312.

NEW ZEALAND: 16-18 William Pickering Drive, Albany 1331, Auckland.

ASIA: Mattel East Asia Ltd, Room 1106, South Tower, World Finance Centre, Harbour City, Tsimshatsui, HK, China.